

Powered by



# EVX 12400 ▶ 12V 40Ah

EVX 12400 is designed specially for electric vehicles, such as electric golf cart, electric wheelchair, mower, dust collector...etc. It has high cycling life, high efficiency and long service life.



## Specification

Cells Per Unit	6
Voltage Per Unit	12
Capacity	40Ah @ 20hr-rate to 1.75V per cell @25 °C (77°F)
Weight	Approx. 12.73 kg (28.06 lbs)
Maximum Discharge Current	400A(5sec)
Internal Resistance	Approx. 10 mΩ
Operating Temperature Range	Discharge: -15°C~50°C ( 5°F~122°F) Charge: -15 °C~40°C ( 5°F~104°F) Storage: -15°C~40°C ( 5°F~104°F)
Nominal Operating Temperature Range	25°C±3°C (77°F±5°F)
Float Charging Voltage	13.5 to 13.8 VDC/unit Average at 25°C (77°F)
Recommended Maximum Charging Current Limit	12 A
Equalization and Cycle Service	14.4 to 15.0 VDC/unit Average at 25°C (77°F)
Self Discharge	CSB Batteries can be stored for more than 6 months at 25°C (77°F). Please charge batteries before using. For higher temperatures the time interval will be shorter.
Terminal	L terminal: B2 or Recessed type to accept M6 bolt
Container Material	ABS(UL 94-HB/File E50263)*Flammability resistance of (UL 94-V0/File E88637) can be available upon request.



MH14533(N)



No :041005117



ISO 14001  
NO.UM 1-12-0045

CSB-manufactured VRLA batteries are UL-recognized components under UL924 and UL1989.

CSB is also certified by ISO 9001 and ISO 14001.

## Dimensions :

Unit: mm (inch)	Overall Height (H)	Container height (h)	Length (L)	Width (W)
	170±2 (6.69±0.08)	168.5±2 (6.63±0.08)	197±2 (7.76±0.08)	165±2 (6.5±0.08)

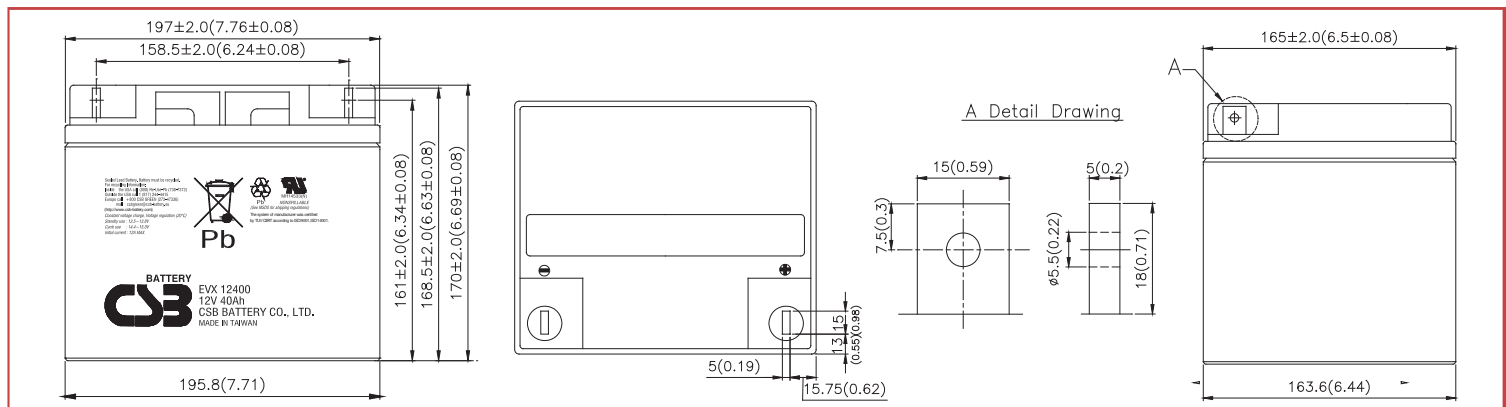

## Constant Current Discharge Characteristics Unit:A (25°C ,77°F)

F.V/Time	30MIN	60MIN	90MIN	2HR	3HR	4HR	5HR	8HR	10HR	20HR
1.60V	38.1	22.9	16.8	13.4	9.75	7.76	6.42	4.31	3.59	2.17
1.67V	37.0	22.3	16.3	13.0	9.47	7.52	6.24	4.18	3.49	2.12
1.70V	35.8	21.7	15.8	12.7	9.17	7.33	6.07	4.05	3.40	2.05
1.75V	34.8	21.0	15.3	12.3	8.88	7.09	5.91	3.94	3.30	2.00
1.80V	33.7	20.3	14.8	11.9	8.58	6.89	5.70	3.82	3.17	1.94
1.85V	32.6	19.5	14.4	11.4	8.29	6.63	5.48	3.68	3.09	1.89

## Constant Power Discharge Characteristics Unit:W (25°C ,77°F)

F.V/Time	30MIN	60MIN	90MIN	2HR	3HR	4HR	5HR	8HR	10HR	20HR
1.60V	457	275	201	162	117	93.0	76.8	49.9	41.1	22.3
1.67V	444	268	196	157	113	90.1	74.6	48.4	40.0	21.6
1.70V	430	260	189	152	110	87.6	72.3	46.9	38.8	20.9
1.75V	417	252	184	147	107	84.5	69.9	45.5	37.6	20.3
1.80V	404	243	178	143	103	81.5	67.4	44.0	36.4	19.6
1.85V	391	235	173	138	99.5	78.9	64.9	42.6	35.2	19.0

### Trickle (or Float) Service Life

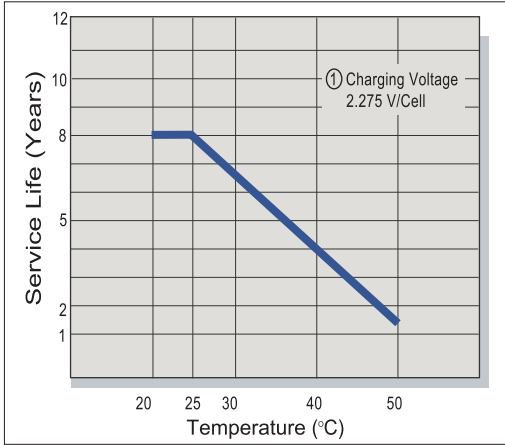

### Capacity Retention Characteristic

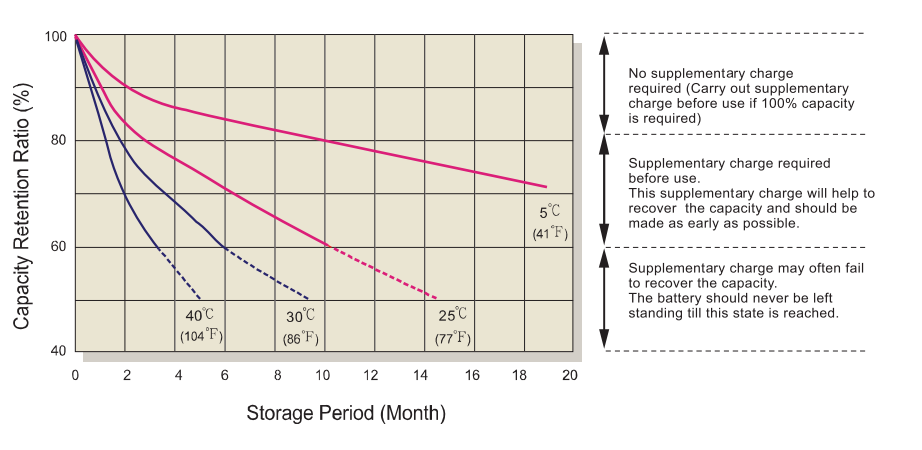

### Battery Voltage and Charge Time for Standby Use

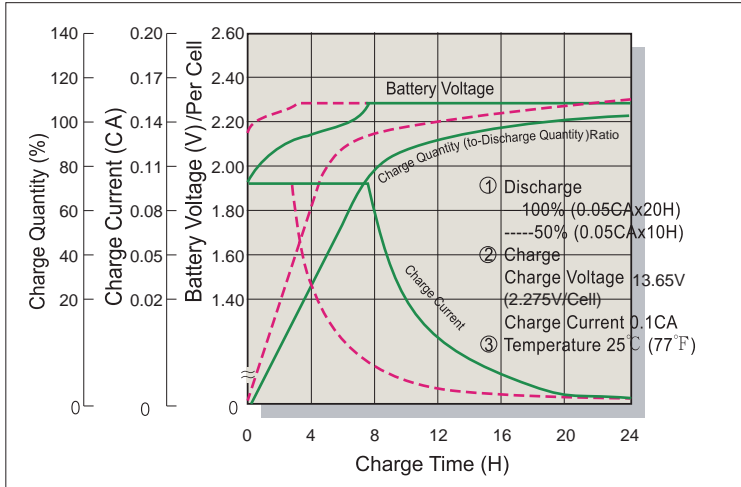

### Series Cycle Service Life

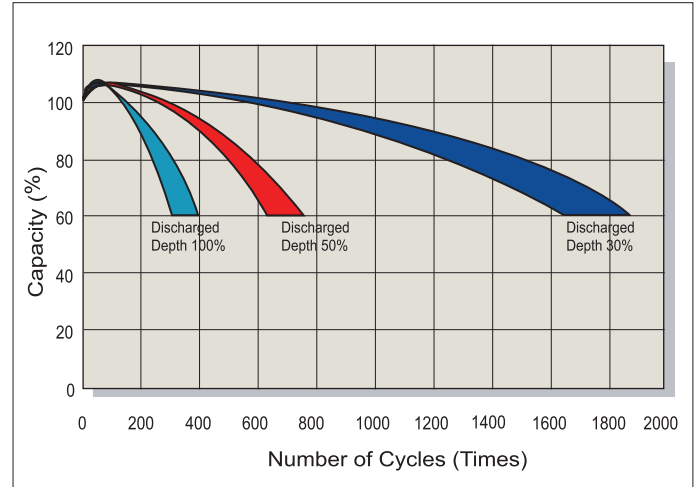

### Battery Voltage and Charge Time for Cycle Use

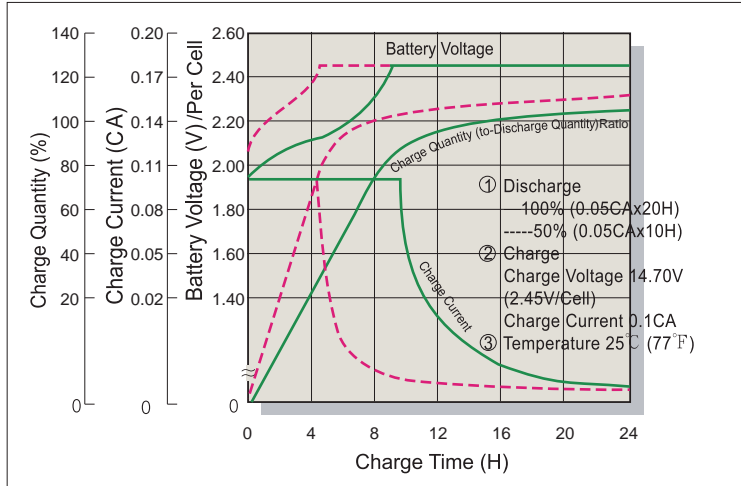

### Terminal Voltage (V) and Discharge Time

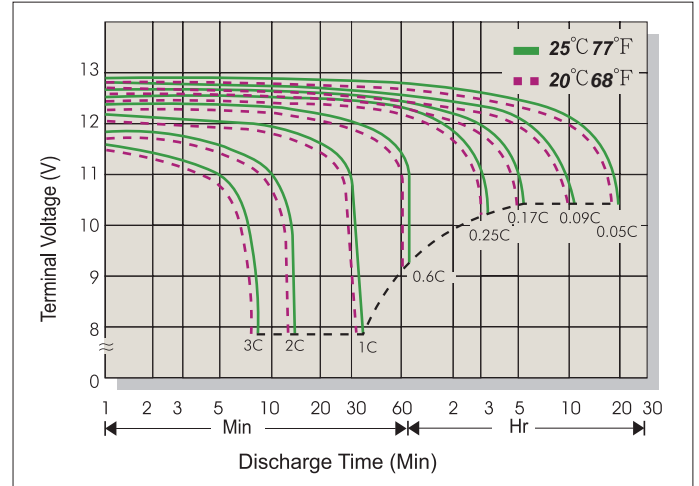

### Charging Procedures

Application	Charge Voltage(V/Cell)			Max.Charge Current
	Temperature	Set Point	Allowable Range	
Cycle Use	25°C(77°F)	2.45	2.40-2.50	0.3C
Standby	25°C(77°F)	2.275	2.25-2.30	

### Discharge Current VS. Discharge Voltage

Final Discharge Voltage V/Cell	1.75	1.70	1.60	1.30
Discharge Current(A)	0.2C>(A)	0.2C<(A)<0.5C	0.5C<(A)<1.0C	(A)>1.0C

Sales Office URL: [WWW.CSB-BATTERY.COM](http://WWW.CSB-BATTERY.COM)

**GLOBAL HQ**  
CSB BATTERY CO., LTD. (TAIWAN)  
Tel : +886-2-2555-5600  
Fax : +886-2-2555-3300  
mail : service@csb-battery.com.tw

**BEIJING OFFICE. (CHINA)**  
CSB BATTERY TECHNOLOGIES (BEIJING) CO., LTD.  
Tel : +86-10-59621300/1301/1302/1303  
Fax : +86-10-59621304  
mail : chinasl@csb-battery.com

**AMERICA HQ**  
CSB BATTERY TECHNOLOGIES INC. (U.S.A)  
Tel : +1-817-244-7777/1-(800)3-CSB-USA(272872)  
Fax : +1-817-244-4445  
mail : csb@csb-battery.com

**SHANGHAI OFFICE. (CHINA)**  
CSB BATTERY LOGISTIC (SHANGHAI) CO., LTD.  
Tel : +86-21-5046-1622/5046-0833  
Fax : +86-21-5064-3314  
mail : chinasl@csb-battery.com

**EUROPE HQ**  
CSB Battery Europe BV.  
Tel : +31(0)-180-418-140  
Fax : +31(0)-180-418-327  
mail : eurosales@csb-battery.eu

**SHENZHEN OFFICE. (CHINA)**  
CSB BATTERY LOGISTIC (SHANGHAI) CO., LTD.  
Tel : +86-755-8831-6488/6396/6356  
Fax : +86-755-8831-6548  
mail : she@csb-battery.com.cn